

CROWN MMCR-131

DETAILS:

Profile:	MMCR-131
Set Up:	5MS
Scale:	1:1

DIMENSIONS AVAILABLE:

	X	Y
Standard:	0.82	3.56
Maximum:	0.82	3.56
Minimum:	0.82	3.56

ADDITIONAL NOTES:

1. All dimensions are given in inches.
2. Tolerance: $\pm 1/32"$.

6178 Mitch Owens Rd
Manotick, Ontario K4M 0V2
Phone: 613-822-6800
Email: info@wood-source.com



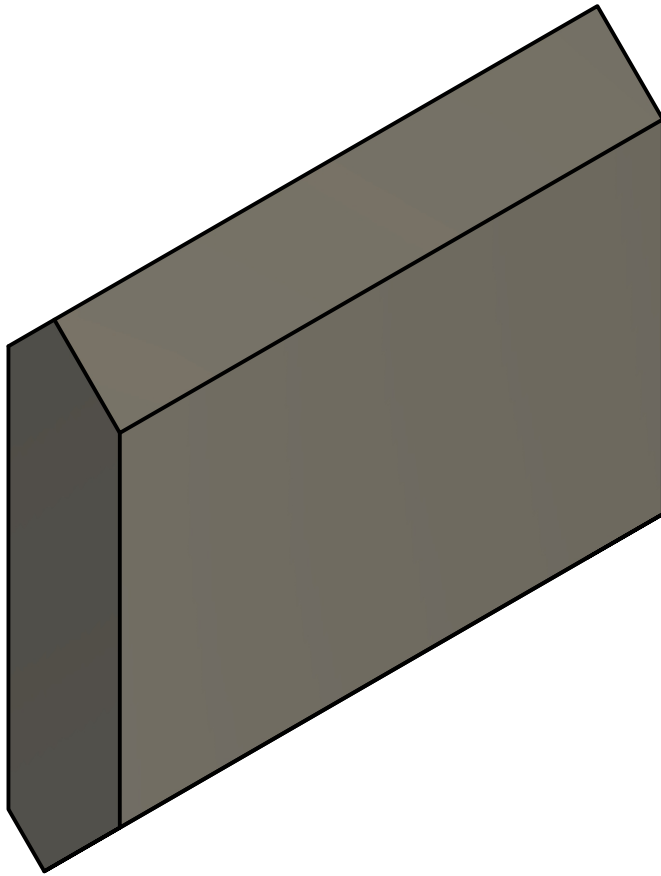

NAME MMCR-131

SCALE 1:1