

CROWN MM CR 122

DETAILS:

Profile:	MM CR 122
Set Up:	5MS
Scale:	1:1

DIMENSIONS AVAILAIBLE:

	X	Y
Standard:	0.85	3.83
Maximum:	0.85	3.83
Minimum:	0.85	3.83

ADDITIONAL NOTES:

1. All dimensions are given in inches.
2. Tolerance: $\pm 1/32"$.

6178 Mitch Owens Rd
Manotick, Ontario K4M 0V2
Phone: 613-822-6800
Email: info@wood-source.com



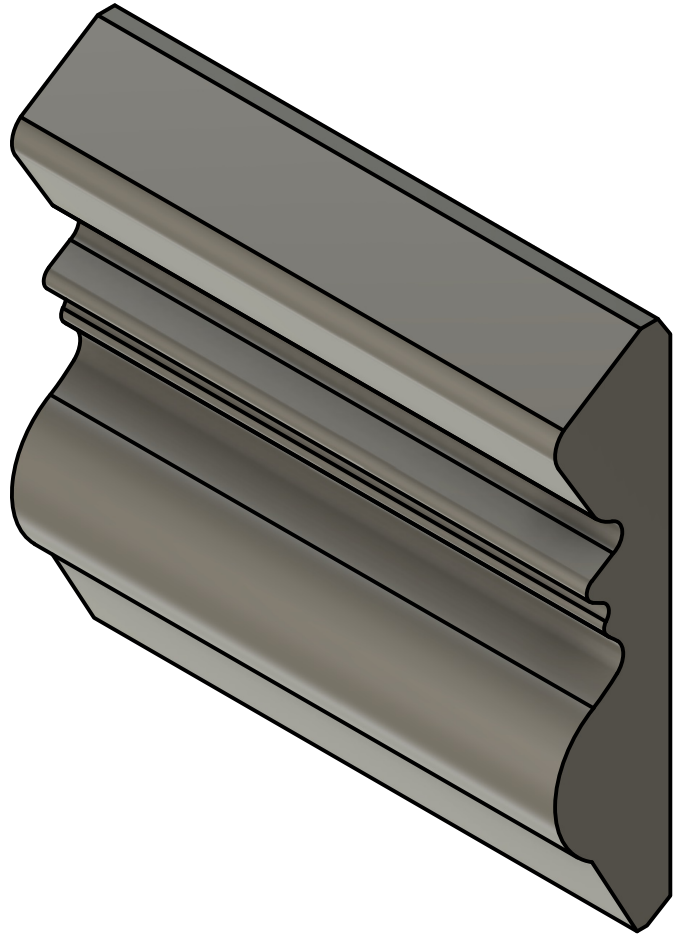
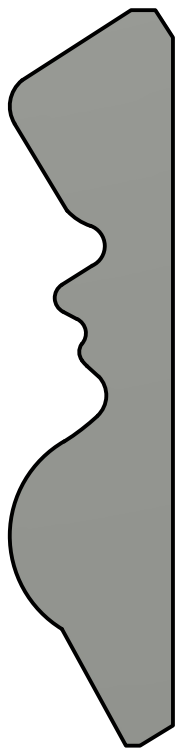

NAME MM CR 122

SCALE 1:1