

## CROWN MM CR 109

### DETAILS:

Profile:	MM CR 108
Set Up:	5MS
Scale:	1:1

### DIMENSIONS AVAILAIBLE:

	X	Y
Standard:	0.58	3.72
Maximum:	0.58	3.72
Minimum:	0.58	3.72

### ADDITIONAL NOTES:

1. All dimensions are given in inches.
2. Tolerance:  $\pm 1/32"$ .

6178 Mitch Owens Rd  
Manotick, Ontario K4M 0V2  
Phone: 613-822-6800  
Email: [info@wood-source.com](mailto:info@wood-source.com)



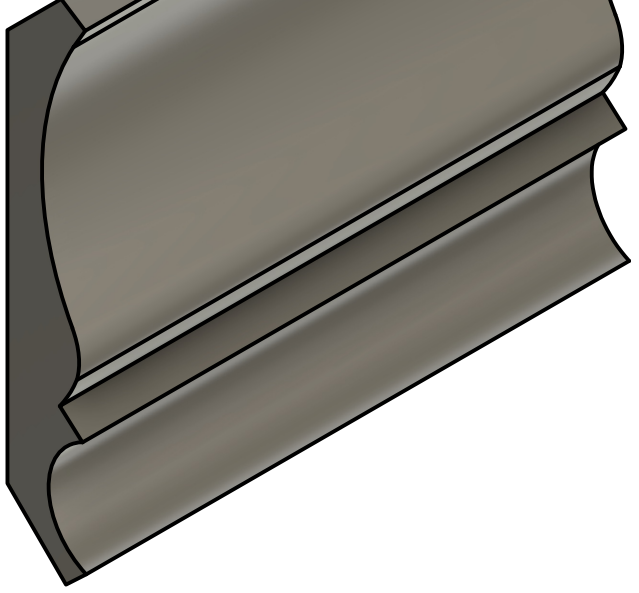
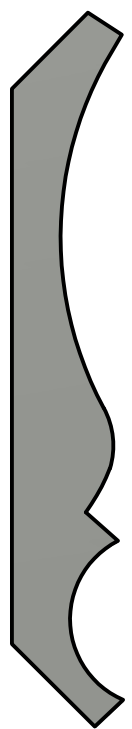

NAME <Project>  
SCALE 1:1